

ArcWorld CS V2-500

for workpiece max. 1200 mm

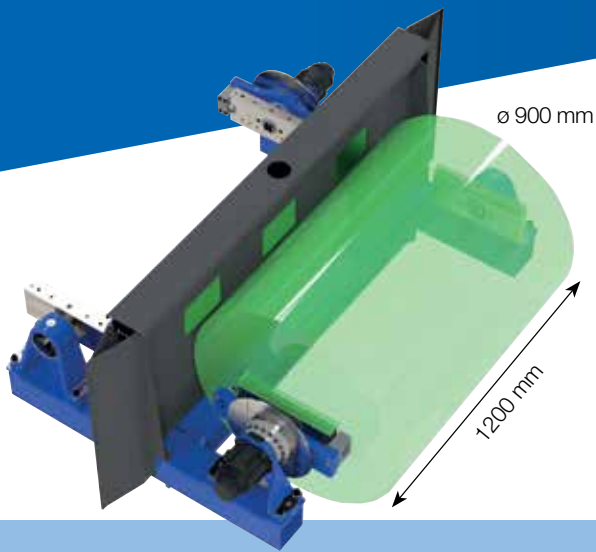

Key benefits

- Short delivery times.
- Easy to install, and to relocate.
- Easy to operate.
- Small footprint, but with generous space for the robot.
- Material can be loaded with an overhead crane.
- Designed for operator ease of use.
- Prepared for offline programming.
- TIG, MIG or MAG welding possible.

ArcWorld

LESS SPACE | MORE OUTPUT

User friendly design

In ArcWorld CS the operator and robot have their own separate working area. This provides the operator with a user friendly and bright workplace with curved sliding doors and the required materials close at hand.

Easy to install

Simply plug in the main power to the power distribution box located on the back of the ArcWorld CS. Internal connection to the robot controller and interior lightning are already in place. In addition to the outlet for the welding power source, the power distribution box also has extra sockets for 230VAC and 400VAC that can be used for other equipment. Sockets for connecting the compressed air are also included.

Easy to move

The wheels on front and rear makes it is easy to move the whole robot cell with a pallet truck.

Controlled by
YRC1000

New generation
Sigma-7

Fixture holder
MotoMount

ArcWorld CS

AW-V2-500 D3

L = 1300 (pin-to-pin)

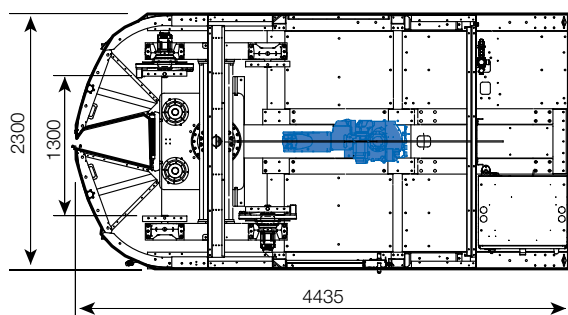
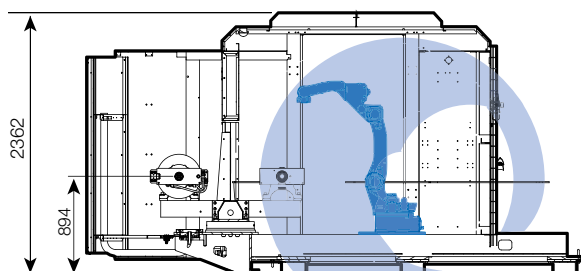

All dimensions are for reference only.

Request detailed drawings for design/engineering requirements!

Scope of delivery

- MOTOMAN-AR1440 welding robot(s).
- Built in V2-500 positioner.
- Platform, metal walls, curved sliding plexi doors.
- Fume hood with outlets for ventilation and exhaust.
- Start panel.
- CE-marking.

Options

- Service door located at the the operator's left.
- Single or twin robot system.
- Media transfer (signal, air, current) for the positioner.
- Retrofit adapter for old fixtures.
- MotoSim with kinematic simulation.
- Integration of welding equipment and power sources of various types and brands.

Technical data

AW-V2-500 Y3 (L=1300)

Payload		500 kg
Maximum workpiece size	width diameter	1200 mm ø 900 mm
Welding capacity	100% duty cycle 60% duty cycle	350 A 460 A
Torque rotating axis	dynamic static	1177 Nm 941 Nm
Torque index axis	dynamic static	1772 Nm 1417 Nm
Motor power	rotating axis index axis	1.3 kW 3.0 kW

YASKAWA



YASKAWA Nordic AB
PO Box 504
SE-385 25 Torsås, SWEDEN

Phone +46 480 41 78 00
info.se@yaskawa.eu.com
www.yaskawa.eu.com